

Stars wardrobe - Stars collection

design Bartoli Design



_System of custom made wardrobes with hinged doors clad with Stars collection metals. The wardrobe is customizable in size, equipment, doors and interior finishes.

_Sistema di armadi realizzati su misura con ante battenti rivestite nei metalli della collezione Stars. L'armadio è personalizzabile nelle dimensioni, attrezzature, rivestimento delle ante, e finiture interne.



_dimensions

columns

colonne - colonnes - Säulen - колонны

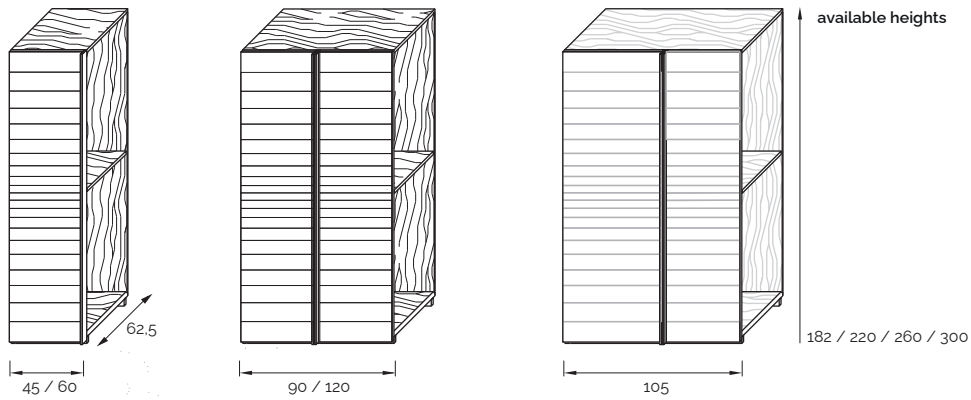

handles detail

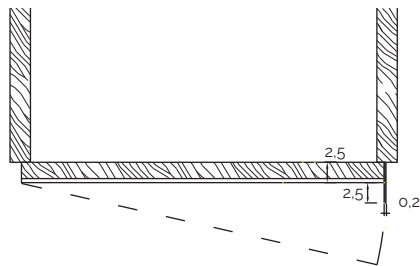

columns handles

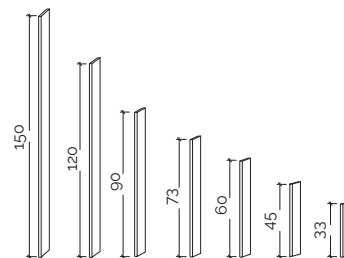

drawers

L. 34 / 49 / 79 / 94 / 109

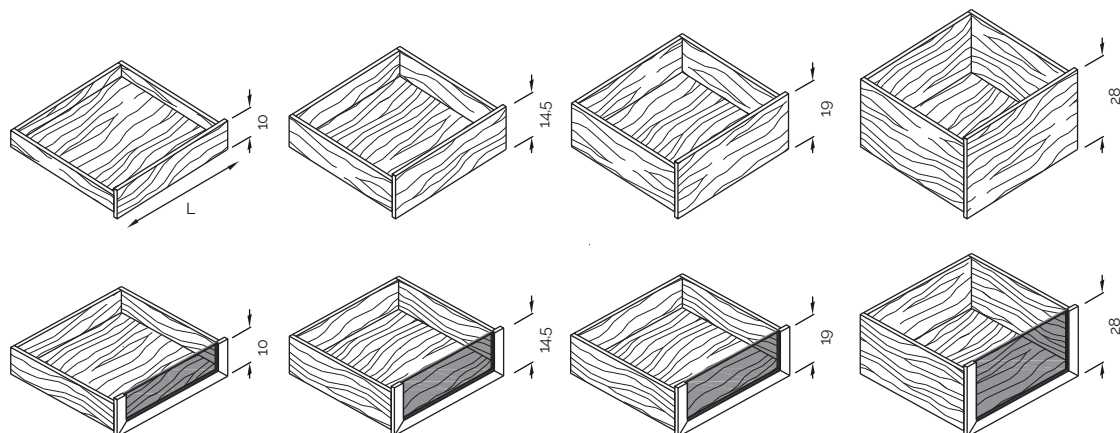

-Dimensions in centimeters and inches.

The right to discontinue and make changes is reserved.

This information is based on the latest product information available at the time of printing.

_dimensions

components

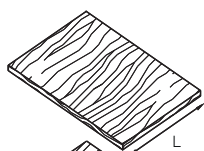

adjustable shelf
L. 42,5 / 57,5 / 87,5 / 102,5 / 117,5

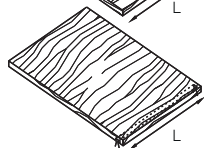

fixed shelf with led
L. 42,5 / 57,5 / 87,5 / 102,5 / 117,5



adjustable crystal shelf
L. 42,5 / 57,5 / 87,5 / 102,5 / 117,5

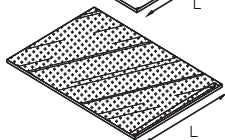

adjustable crystal fumé shelf
L. 42,5 / 57,5 / 87,5 / 102,5 / 117,5

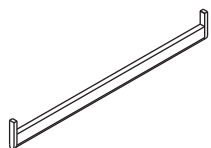

hanging rails

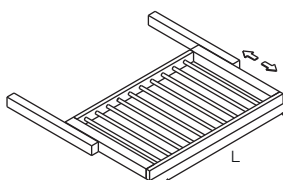

trays for trousers and skirts
L. 34 / 49 / 79 / 94 / 109

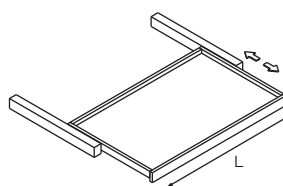

pull-out tray
L. 34 / 49 / 79 / 94 / 109

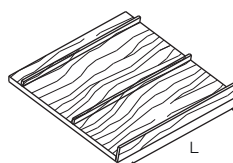

shoe rack
L. 42,5 / 57,5 / 87,5 / 102,5 / 117,5

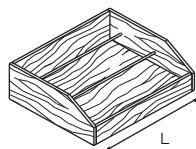

internal shoe drawer
L. 34 / 49 / 79 / 94 / 109

vertical
onda carved wood

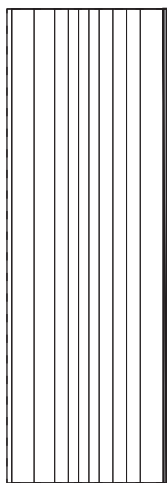

horizontal
onda carved wood

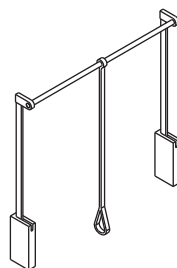
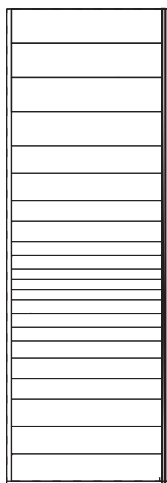

pull down
hanging bar

-Dimensions in centimeters and inches.
The right to discontinue and make changes is reserved.
This information is based on the latest product information available at the time of printing.

_dimensions

element for hight storage unit

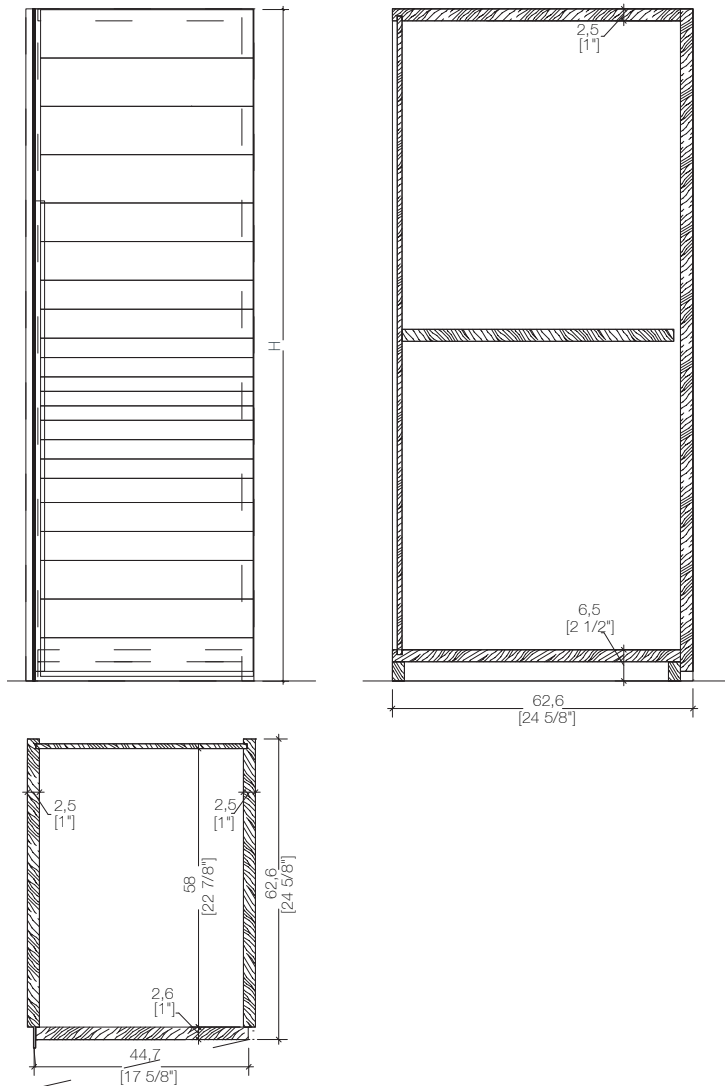

-Dimensions in centimeters and inches.
The right to discontinue and make changes is reserved.
This information is based on the latest product information available at the time of printing.

_dimensions

element for corner high storage unit

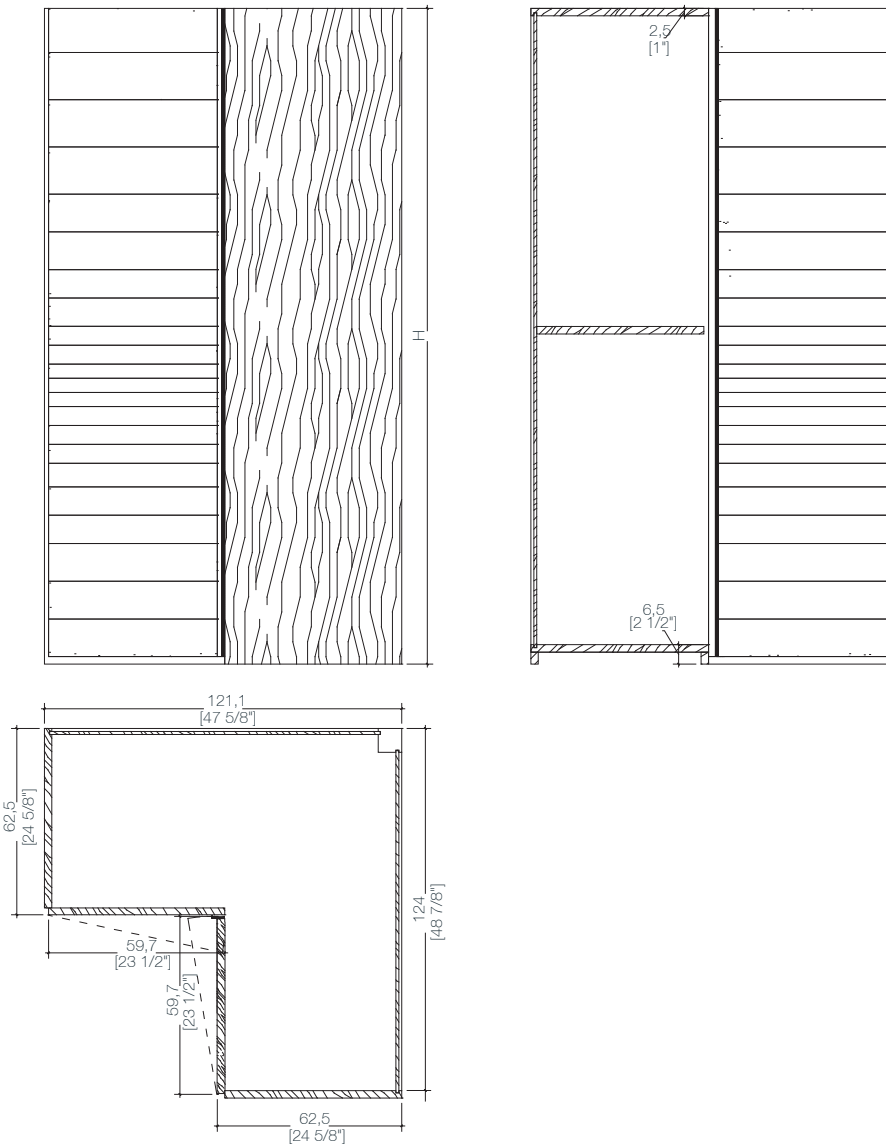

-Dimensions in centimeters and inches.
The right to discontinue and make changes is reserved.
This information is based on the latest product information available at the time of printing.

_materials & finishes

metals



Black Iron "Genere"



Polished Steel



Burnished brass



Satin brass



Satin copper



Burnished copper

_The finishes shown are indicative and refer to the entire production range.
Laurameroni reserves the right to modify the range without warning.

_maintenance

_METAL

Natural deviations in structure and colour of metals are part of the authenticity of this surface and are typical of the goods. The surface is specially hand-crafted in several complex manufacturing steps. At the end of the galvanic procedure, the surface is painted with a transparent protective lacquer which prevents further oxidising and discolouring. Differences in colour and structure are not faults, but typical of the goods, and are characteristics of manual processing: every piece is unique. For cleaning and maintenance do not use any acid, solvents or alkali-based cleaners. Do not use scouring agents, steel wool, pot cleaners or similar. Pointed or sharp objects, such as blades or knives, can damage the surface. Anything hot or damp can also be detrimental to the surface. Remove light soiling with a soft cloth and a neutral household cleaning product diluted in water. Clean the metal parts with cold or hand-hot water and finish by immediately drying with a soft cloth.

Le deviazioni naturali nella struttura e nel colore dei metalli fanno parte dell'autenticità di questa superficie e sono tipiche dei prodotti. La superficie è appositamente realizzata a mano in diverse fasi di produzione complesse. Al termine della procedura galvanica, la superficie viene verniciata con una vernice protettiva trasparente che impedisce ulteriore ossidazione e scolorimento. Le differenze di colore e struttura non sono difetti, ma tipici dei prodotti e sono caratteristiche della lavorazione manuale: ogni pezzo è unico. Per la pulizia e manutenzione non utilizzare detergenti acidi, solventi o alcali. Non usare agenti abrasivi, lana d'acciaio, detergenti per pentole o simili. Oggetti appuntiti o taglienti, come lame o coltelli, possono danneggiare la superficie. Qualsiasi cosa calda o umida può anche essere dannosa per la superficie. Rimuovere lo sporco leggero con un panno morbido e un prodotto per la pulizia neutro della casa diluito in acqua. Pulire le parti metalliche con acqua fredda o calda a mano e finire asciugando immediatamente con un panno morbido.

**BEDIF
FEREN
TBEUN
IQUE.**

LAURAMERONI s.r.l.
22040 Alzate Brianza (Como)
Via Manzoni, 2784
T +39 031 761450
info@laurameroni.com
www.laurameroni.com