

Bamboo wardrobe - Bamboo collection

design Diego Maria Piovesan



System of custom made wardrobes with hinged doors in lacquered wood with carved channels and profiles of the Bamboo collection. The wardrobe is customizable in size, equipment, doors and interior finishes.

Sistema di armadi realizzati su misura con ante battenti in legno laccato della collezione Bamboo. L'armadio è personalizzabile nelle dimensioni, attrezzature, rivestimento delle ante e finiture interne.



_dimensions

columns

colonne - colonnes - Säulen - колонны

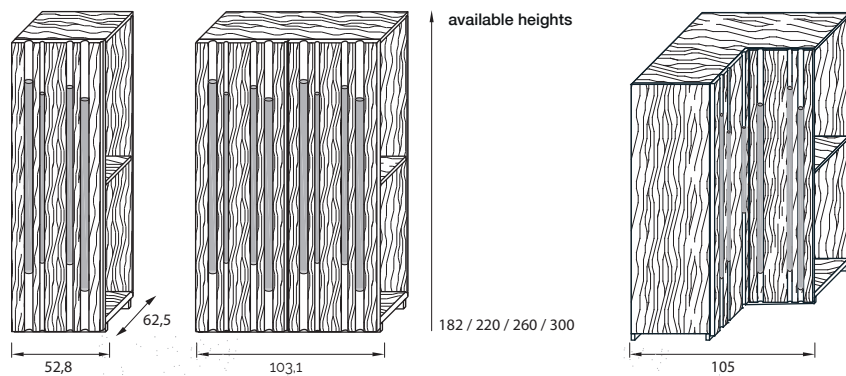

handles detail

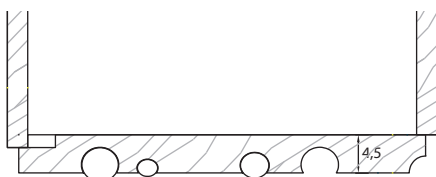

channels details

- A 2,5 x 2 cm h. 100/120/140/160
- B 3,5 x 3 cm h. 100/120/140/160
- C 4,5 x 4 cm h. 100/120/140/160

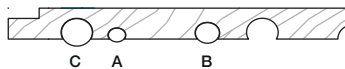

drawers

L. 34 / 49 / 79 / 94 / 109

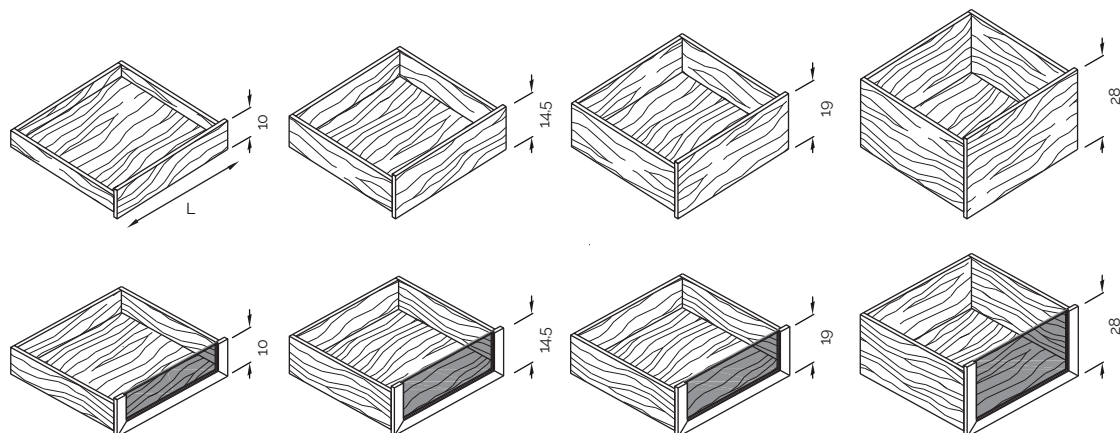

-Dimensions in centimeters and inches.

The right to discontinue and make changes is reserved.

This information is based on the latest product information available at the time of printing.

_dimensions

components

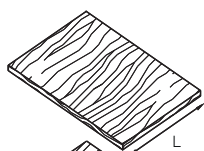

adjustable shelf
L. 42,5 / 57,5 / 87,5 / 102,5 / 117,5

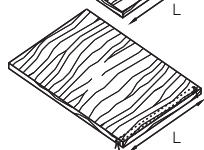

fixed shelf with led
L. 42,5 / 57,5 / 87,5 / 102,5 / 117,5



adjustable crystal shelf
L. 42,5 / 57,5 / 87,5 / 102,5 / 117,5

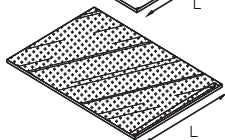

adjustable crystal fumé shelf
L. 42,5 / 57,5 / 87,5 / 102,5 / 117,5

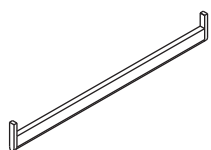

hanging rails

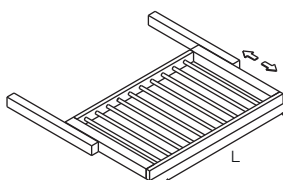

trays for trousers and skirts
L. 34 / 49 / 79 / 94 / 109

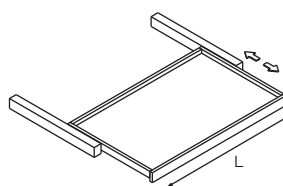

pull-out tray
L. 34 / 49 / 79 / 94 / 109

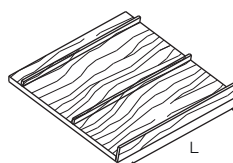

shoe rack
L. 42,5 / 57,5 / 87,5 / 102,5 / 117,5

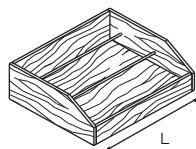

internal shoe drawer
L. 34 / 49 / 79 / 94 / 109

plain wood veneered
bamboo door

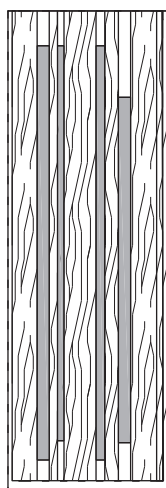

matt lacquered
bamboo door

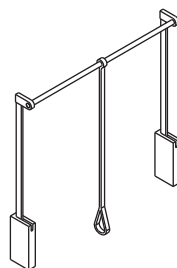
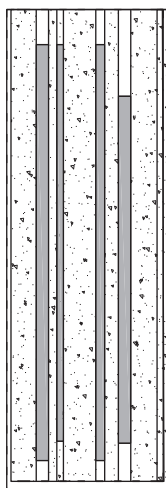

pull down
hanging bar

-Dimensions in centimeters and inches.
The right to discontinue and make changes is reserved.
This information is based on the latest product information available at the time of printing.

_dimensions

element for hight storage unit

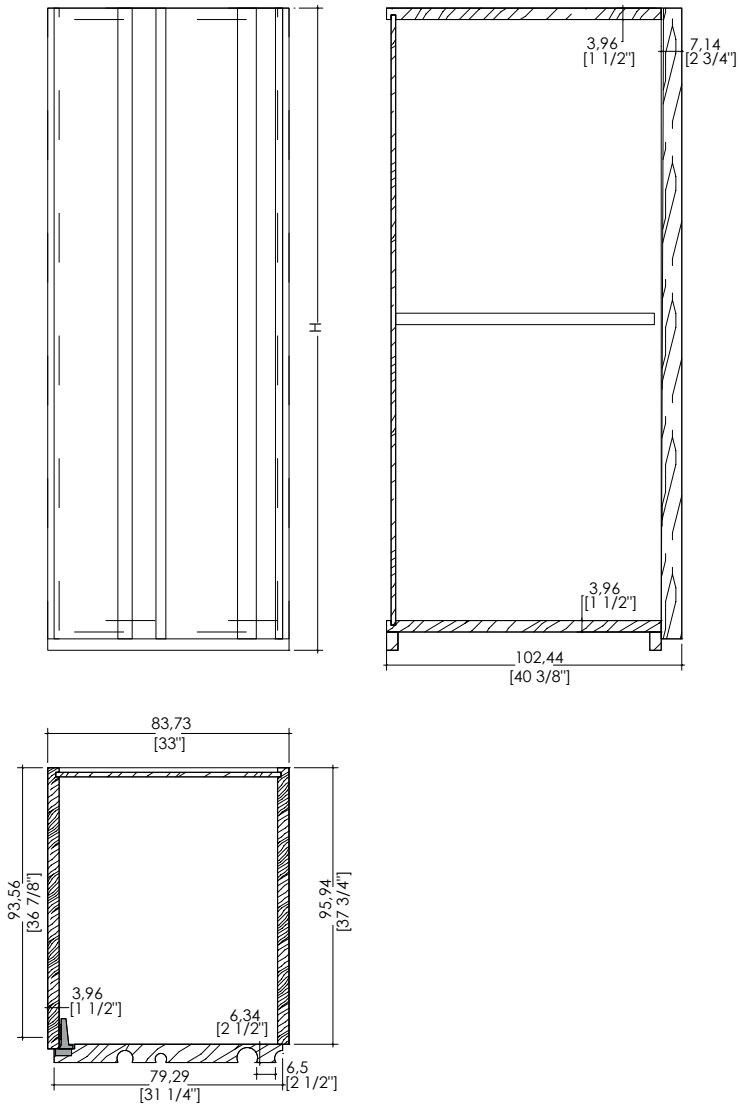

-Dimensions in centimeters and inches.
The right to discontinue and make changes is reserved.
This information is based on the latest product information available at the time of printing.

_dimensions

element for corner high storage unit

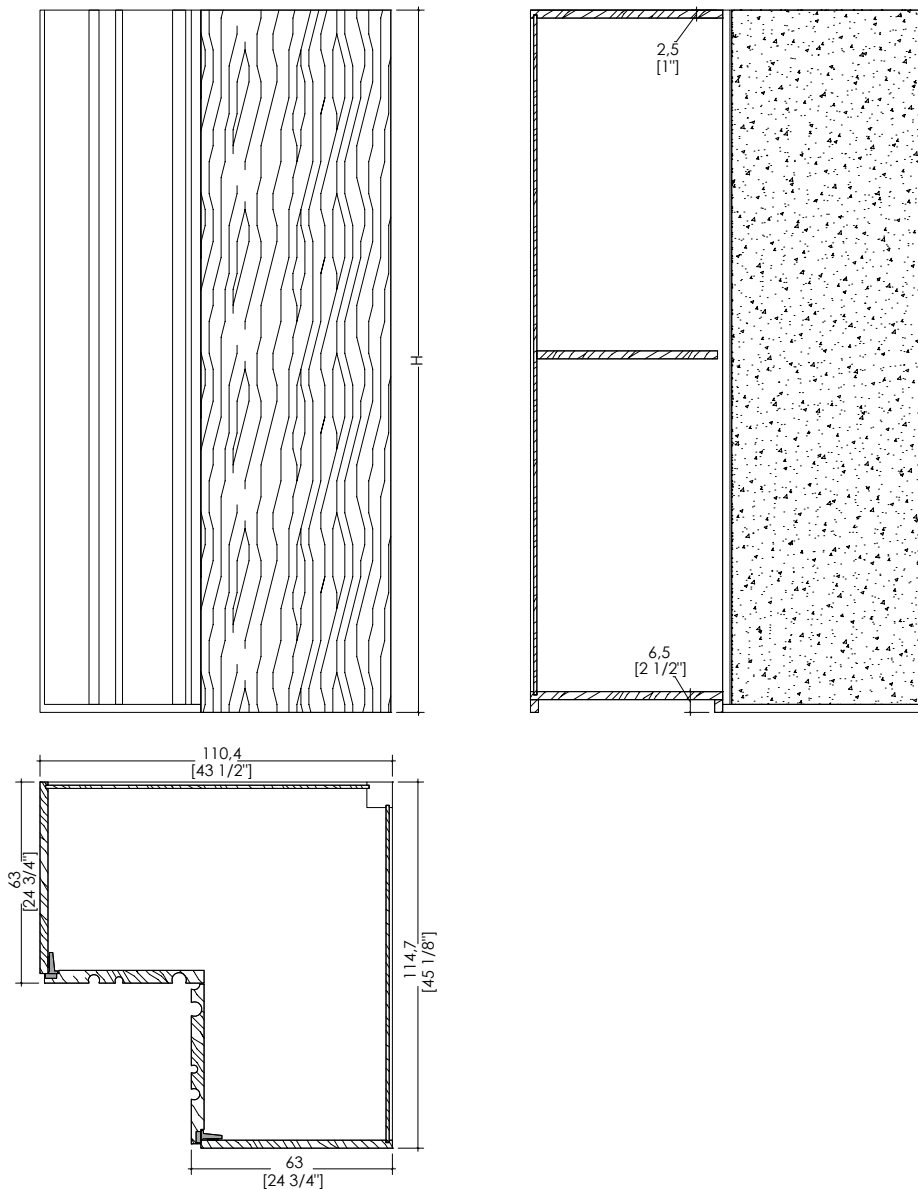

-Dimensions in centimeters and inches.
The right to discontinue and make changes is reserved.
This information is based on the latest product information available at the time of printing.

_materials & finishes

plain woods



Maple



Oak



Teak



Zebrano



Canaletto Walnut

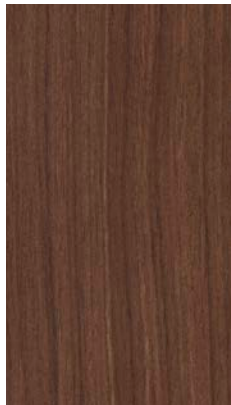

Dyed Canaletto walnut



Ebony



Termocotto Oak



Rosewood



Wenge



Aniline dyed



Available in all
RAL / NCS colors

_The finishes shown are indicative and refer to the entire production range.
Laurameroni reserves the right to modify the range without warning.

_materials & finishes

matt lacquered



Brushed matt lacquered



Available in all
RAL / NCS colors

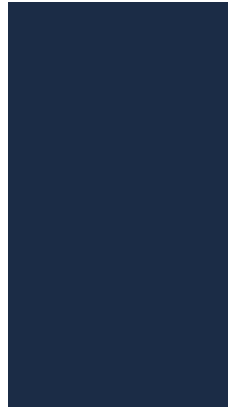

Matt lacquered



Available in all
RAL / NCS colors

_The finishes shown are indicative and refer to the entire production range.
Laurameroni reserves the right to modify the range without warning.

_maintenance

LACQUERED WOODS

Do not use acid or alkali-based cleaners. Do not use scouring agents, steel wool, pot cleaners or similar. Do not use solvents to clean painted surfaces. Pointed or sharp objects, such as blades or knives, can damage (scratch) the surface. Anything hot or damp will cause damage to the surface. Clean painted surfaces with a clean, soft, lint-free cloth to avoid abrasion with particles of dirt. For soft-finish paint surfaces, use a soft, lint-free, slightly damp cloth. If heavily soiled, paint surfaces can be cleaned more easily with a neutral (silicone-free) cleaning agent. Do not use furniture polish or other care products to clean soft-finish paint surfaces. It is then essential to rub the surface dry, so that there is no residual moisture. Clean painted surfaces regularly with a soft, lint-free cloth to remove dust.

Non utilizzare detergenti acidi o alcali. Non usare agenti abrasivi, lana d'acciaio, detergenti per pentole o simili. Non usare solventi per pulire le superfici verniciate. Oggetti appuntiti o taglienti, come lame o coltelli, possono danneggiare (graffiare) la superficie. Qualsiasi cosa calda o umida causerà danni alla superficie. Pulire le superfici verniciate con un panno pulito, morbido e privo di lanugine per evitare l'abrasione con particelle di sporco. Per superfici di vernice con finitura morbida, utilizzare un panno morbido, privo di lanugine e leggermente umido. Se molto sporchi, le superfici verniciate possono essere pulite più facilmente con un detergente neutro (privo di silicone). Non utilizzare lucidi per mobili o altri prodotti per la cura per pulire le superfici di vernice. È quindi essenziale strofinare delicatamente la superficie asciutta, in modo che non vi sia umidità residua. Pulire regolarmente le superfici verniciate con un panno morbido e privo di lanugine per rimuovere la polvere.

_maintenance

_WOOD

Wood is a high-quality natural product. To maintain the natural character of wood and to protect surfaces from mechanical and chemical wear, veneered surfaces are coated with a high quality transparent paint. For cleaning and care, do not use acids or alkali-based cleaners, agents with bleaching additive, scouring powder, steel wool, pot scourers or similar. Anything hot or damp will cause damage to the surface. Remove soiling and liquids immediately. Use a dry soft cloth for cleaning, eventually add a little neutral cleaning agent to the water. The cloth must be only slightly damp, to prevent discolouration or swelling of the surface. It is then essential to rub the surfaces dry, so that there is no residual moisture.

Le deviazioni naturali nella struttura e nel colore dei metalli fanno parte dell'autenticità di questa superficie e sono tipiche dei prodotti. La superficie è appositamente realizzata a mano in diverse fasi di produzione complesse. Al termine della procedura galvanica, la superficie viene verniciata con una vernice protettiva trasparente che impedisce ulteriore ossidazione e scolorimento. Le differenze di colore e struttura non sono difetti, ma tipici dei prodotti e sono caratteristiche della lavorazione manuale: ogni pezzo è unico. Per la pulizia e manutenzione non utilizzare detergenti acidi, solventi o alcali. Non usare agenti abrasivi, lana d'acciaio, detergenti per pentole o simili. Oggetti appuntiti o taglienti, come lame o coltelli, possono danneggiare la superficie. Qualsiasi cosa calda o umida può anche essere dannosa per la superficie. Rimuovere lo sporco leggero con un panno morbido e un prodotto per la pulizia neutro della casa diluito in acqua. Pulire le parti metalliche con acqua fredda o calda a mano e finire asciugando immediatamente con un panno morbido.

**BEDIF
FEREN
TBEUN
IQUE.**

LAURAMERONI s.r.l.
22040 Alzate Brianza (Como)
Via Manzoni, 2784
T +39 031 761450
info@laurameroni.com
www.laurameroni.com