

Drapé lounge - Drapé collection

design Bartoli Design



Upholstered swivel armchair, covered with a soft drapery. Base in "Grey Mouse" RAL 7005 lacquered metal.

Available in leather and in matt "Lario" or glossy "Roxana" velvet.

Poltroncina girevole imbottita, rivestita da un morbido drappeggio. Base in metallo laccato "Grigio Topo" RAL 7005.

Disponibile in pelle ed in velluto opaco "Lario" o lucido "Roxana".



_dimensions

BD 76 swivel small armchair - poltroncina girevole -
drehbarer sessel - petit fauteuil pivotant - Вращающееся

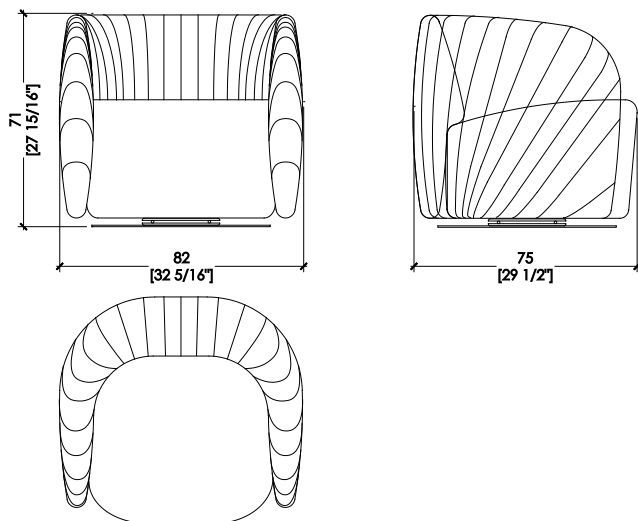

-Dimensions in centimeters and inches.
The right to discontinue and make changes is reserved.
This information is based on the latest product information available at the time of printing.

_materials & finishes

nubuck leathers



Nubuck 2100
Category A



Nubuck 2133
Category A

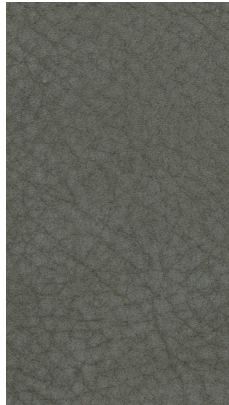

Nubuck 2115
Category A



Nubuck 2118
Category A



Nubuck 2101
Category A



Nubuck 2105
Category A

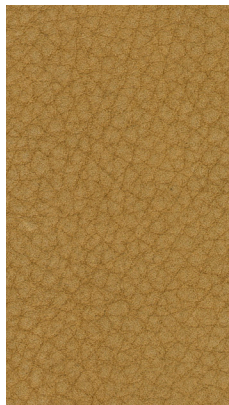

Nubuck 2102
Category A



Nubuck 2132
Category A



Nubuck 2103
Category A



Nubuck 2104
Category A



Nubuck 2116
Category A



Nubuck 2119
Category A

_The finishes shown are indicative and refer to the entire production range.
Laurameroni reserves the right to modify the range without warning.

_materials & finishes

nubuck leathers



Nubuck 2125
Category A



Nubuck 2135
Category A



Nubuck 2109
Category A



Nubuck 2106
Category A



Nubuck 2136
Category A

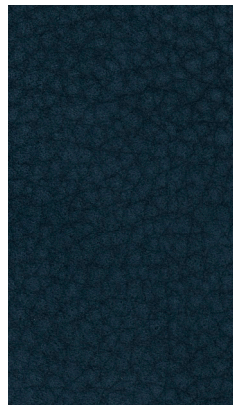

Nubuck 2108
Category A



Nubuck 2137
Category A



Nubuck 2134
Category A



Nubuck 2120
Category A

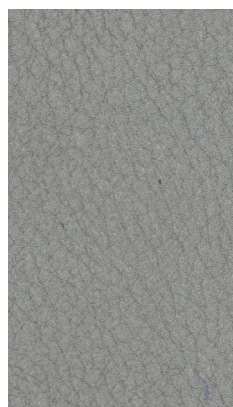

Nubuck 2130
Category A

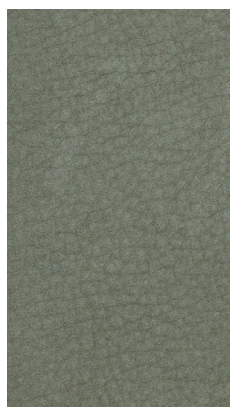

Nubuck 2107
Category A



Nubuck 2117
Category A

_The finishes shown are indicative and refer to the entire production range.
Laurameroni reserves the right to modify the range without warning.

_materials & finishes

nubuck leathers

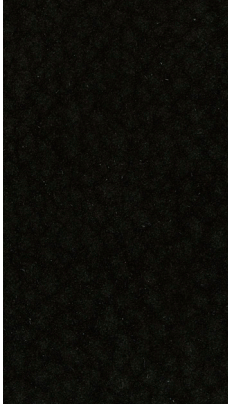

Nubuck 2114
Category A

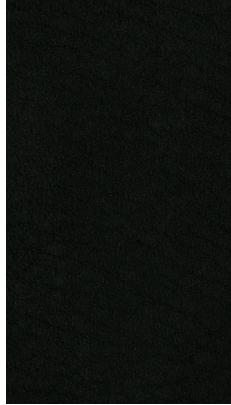

Nubuck 2138
Category A

_The finishes shown are indicative and refer to the entire production range.
Laurameroni reserves the right to modify the range without warning.

_materials & finishes

montana leathers



Montana 1302
Category B



Montana 1304
Category B

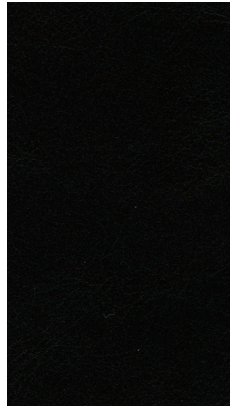

Montana 1305
Category B



Montana 1303
Category B

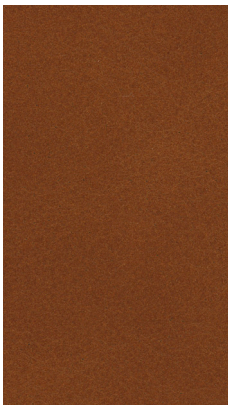

Montana 1301
Category B



Montana 1306
Category B

_The finishes shown are indicative and refer to the entire production range.
Laurameroni reserves the right to modify the range without warning.

_materials & finishes

savana leathers



Savana 1008
Category B



Savana 1007
Category B



Savana 1003
Category B



Savana 1004
Category B



Savana 1012
Category B



Savana 1009
Category B



Savana 1002
Category B



Savana 1006
Category B



Savana 1001
Category B



Savana 1005
Category B

_The finishes shown are indicative and refer to the entire production range.
Laurameroni reserves the right to modify the range without warning.

_materials & finishes

cloud leathers

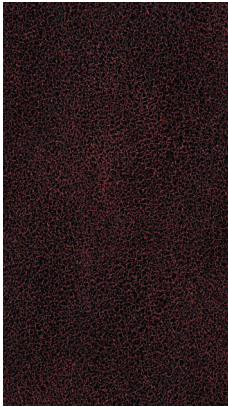

Cloud 4109
Category C



Cloud 3403
Category C



Cloud 6048
Category C



Cloud 1015
Category C



Cloud 779
Category C



Cloud 6099
Category C

_The finishes shown are indicative and refer to the entire production range.
Laurameroni reserves the right to modify the range without warning.

_materials & finishes

matt velvets "lario"



Lario 60



Lario 01



Lario 02



Lario 63



Lario 61



Lario 64



Lario 03



Lario 04



Lario 1012



Lario 06



Lario 05

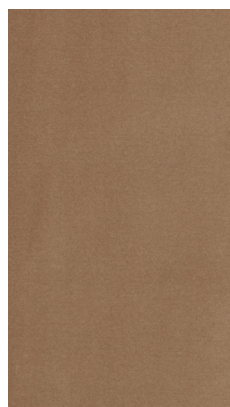

Lario 23

_The finishes shown are indicative and refer to the entire production range.
Laurameroni reserves the right to modify the range without warning.

_materials & finishes

matt velvets "lario"

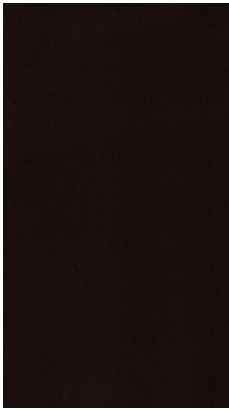

Lario 07



Lario 62



Lario 29



Lario 28

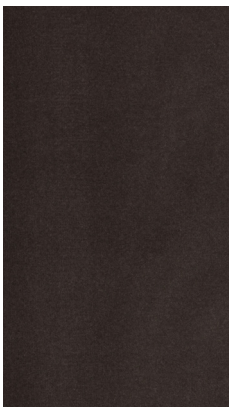

Lario 2003

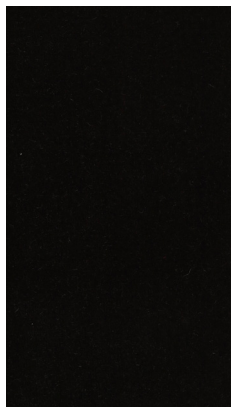

Lario 2002

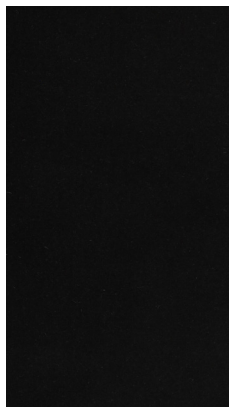

Lario 1404

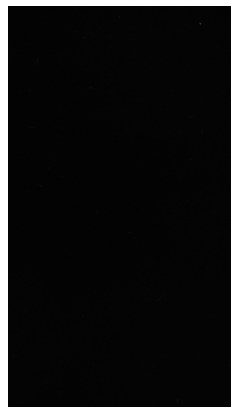

Lario 26

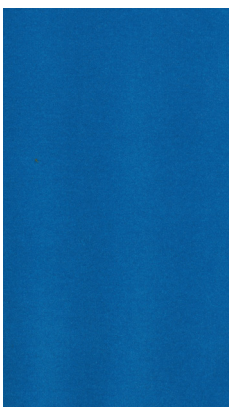

Lario 32



Lario 1406



Lario 1402



Lario 68

_The finishes shown are indicative and refer to the entire production range.
Laurameroni reserves the right to modify the range without warning.

materials & finishes

matt velvets "lario"



Lario 58



Lario 69



Lario 21

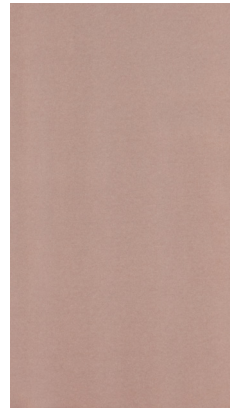

Lario 65



Lario 66



Lario 20

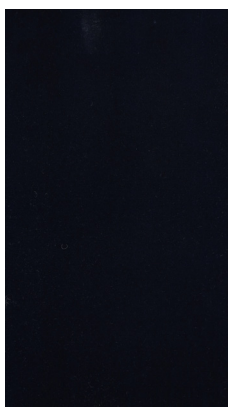

Lario 54



Lario 2004



Lario 19

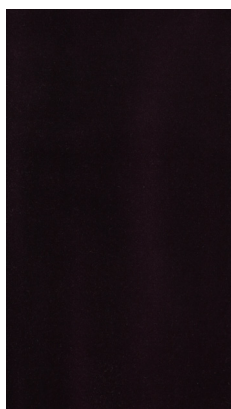

Lario 67



Lario 31



Lario 17

The finishes shown are indicative and refer to the entire production range.
Laurameroni reserves the right to modify the range without warning.

_materials & finishes

matt velvets "lario"

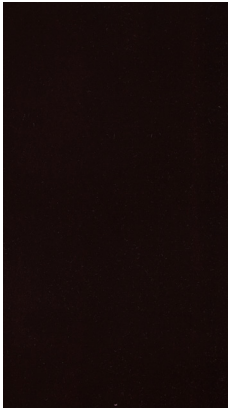

Lario 2007

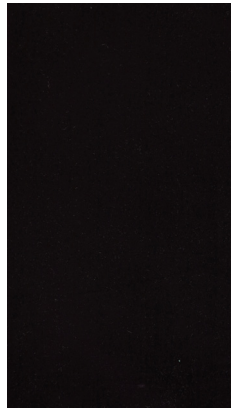

Lario 2006

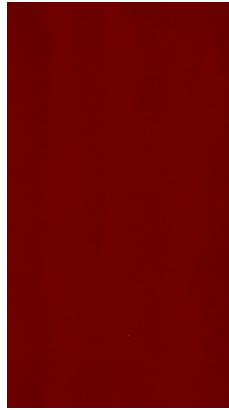

Lario 2008

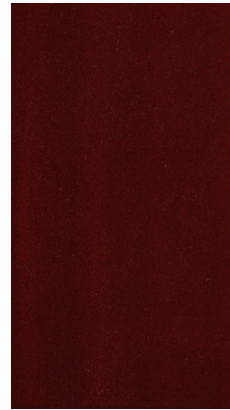

Lario 1405

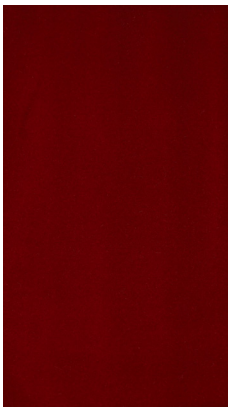

Lario 70



Lario 14

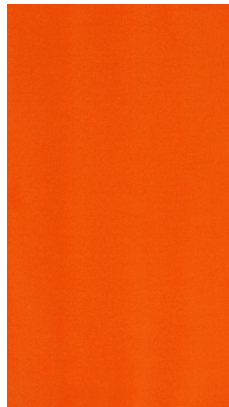

Lario 33



Lario 1101

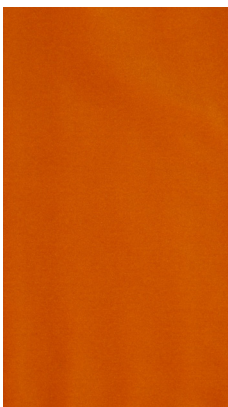

Lario 13



Lario 72

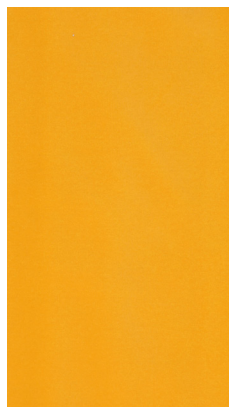

Lario 34



Lario 1403

_The finishes shown are indicative and refer to the entire production range.
Laurameroni reserves the right to modify the range without warning.

_materials & finishes

matt velvets "lario"



Lario 74

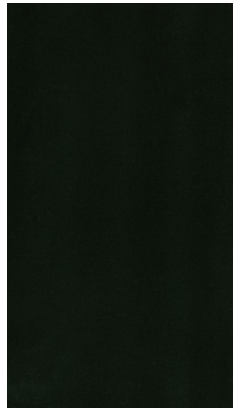

Lario 71



Lario 40



Lario 73

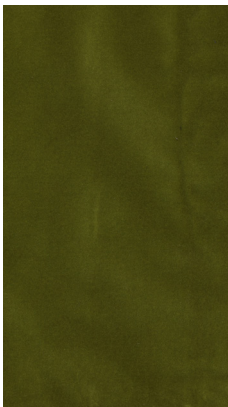

Lario 09

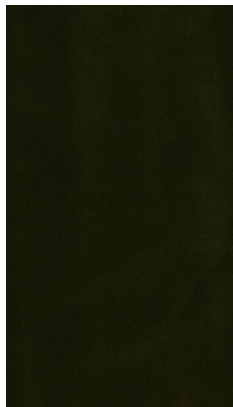

Lario 1401

_The finishes shown are indicative and refer to the entire production range.
Laurameroni reserves the right to modify the range without warning.

_materials & finishes
shiny velvets "roxana"

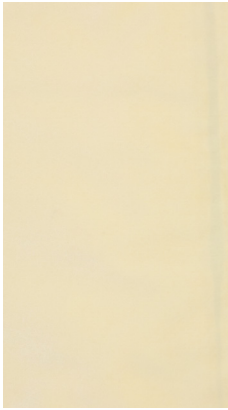

Roxana 02



Roxana 03



Roxana 1720



Roxana 1715



Roxana 33



Roxana 04



Roxana 1709



Roxana 1708



Roxana 08

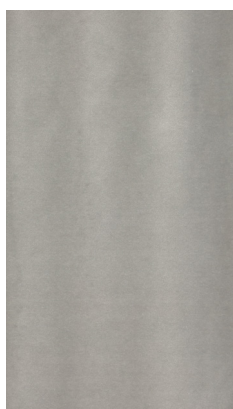

Roxana 18



Roxana 19



Roxana 17

_The finishes shown are indicative and refer to the entire production range.
Laurameroni reserves the right to modify the range without warning.

_materials & finishes
shiny velvets "roxana"



Roxana 11



Roxana 12



Roxana 1726



Roxana 16



Roxana 1001



Roxana 111



Roxana 1716



Roxana 1722



Roxana 35



Roxana 7



Roxana 9

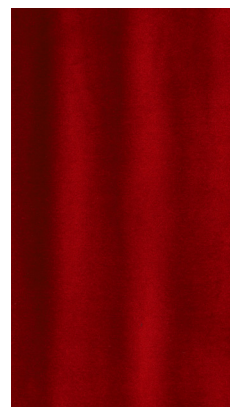

Roxana 1000

_The finishes shown are indicative and refer to the entire production range.
Laurameroni reserves the right to modify the range without warning.

_materials & finishes
shiny velvets "roxana"



Roxana 1717

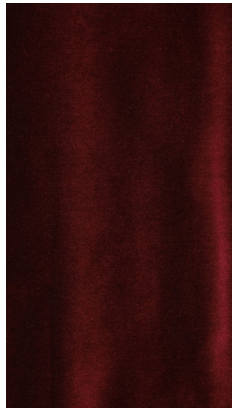

Roxana 10



Roxana 30



Roxana 28



Roxana 1004



Roxana 5

_The finishes shown are indicative and refer to the entire production range.
Laurameroni reserves the right to modify the range without warning.

_maintenance

WOOD

To maintain the natural wood features and protect them from mechanical and chemical wear, the veneered surfaces are coated with a high-quality transparent varnish.

Do not use acid or alkaline detergents, agents with bleaching additives, abrasive powders, steel wool, sponges or the like. Anything hot or humid can cause surface damage. Remove dirt and liquids immediately.

For the cleaning and care, it is best to use a soft, dry cloth. If necessary, the cloth can be slightly dampened and dipped in neutral detergent thoroughly diluted in water. The cloth should only be slightly damp to avoid discoloration or swelling of the surface. Finally, it is essential to gently rub dry surfaces, so that there is no residual moisture.

LEGNO

Per mantenere il carattere naturale del legno e proteggerlo dall'usura meccanica e chimica, le superfici impiallacciate sono rivestite con una vernice trasparente di alta qualità.

Non usare detergenti acidi o alcalini, agenti con additivi sbiancanti, polveri abrasive, lana d'acciaio, spugne o simili. Qualsiasi cosa calda o umida può causare danni alla superficie. Rimuovere immediatamente sporco e liquidi.

Per la pulizia e la cura, è preferibile utilizzare un panno morbido e asciutto. Eventualmente il panno può essere leggermente inumidito ed intinto in detergente neutro abbondantemente diluito in acqua. Il panno deve essere solo leggermente umido, per evitare scolorimenti o rigonfiamenti della superficie. È infine essenziale strofinare gentilmente le superfici asciutte, in modo che non sussista umidità residua.

_maintenance

LEATHER

The finish of the finest leathers can be seriously damaged through the use of improper or unsuitable products; damage occurs over time, after several cleaning operations. Do not use acids or alkali-based cleaners. Never use stain removers, shoe cream, solvents, floor wax, cosmetics or other harsh cleaners. Do not use abrasive agents, steel wool, pot cleaners or similar. It is recommended to protect the product from abrasion, humidity and other factors so that the surface is not irreparably damaged. It is advisable not to expose the product to strong heat sources, as this can alter its appearance. For cleaning and care, regularly wipe the leather surface with a soft cloth. Use the blunt nozzle of a vacuum cleaner to remove any crumbs and sand.

Attention: Nubuck grain leathers as well as leathers finished with aniline cannot be absolutely cleaned, except with a simple soft and completely dry cloth. Any product could irreparably damage the skin.

PELLE

La finitura delle pelli più pregiate può danneggiarsi gravemente con l'uso di prodotti impropri o non idonei; i danni si manifestano con il passare del tempo, dopo diverse operazioni di pulizia. Non utilizzare acidi o detergenti a base di alcali. Non usare mai smacchiatori, crema per scarpe, solventi, cera per pavimenti, cosmetici o altri detergenti aggressivi. Non utilizzare agenti abrasivi, lana d'acciaio, detergenti per pentole o simili. Si consiglia di proteggere il prodotto da abrasione, umidità e altri fattori in modo che la superficie non venga danneggiata irreparabilmente. Si consiglia di non esporre il prodotto a forti fonti di calore, poiché questo può alterarne l'aspetto. Per la pulizia e la cura, spolverare regolarmente la superficie della pelle con un panno morbido. Utilizzare l'ugello smussato di un'aspirapolvere per rimuovere eventuali briciole e sabbia.

Attenzione: le pelli fiore Nabuk così come le pelli rifinite con anilina non possono essere assolutamente pulite, se non con un semplice panno morbido e completamente asciutto. Qualsiasi prodotto potrebbe danneggiare irreparabilmente la pelle.

_maintenance

VELVET

Our velvet fabrics must be dry cleaned. Deep cleaning and spot cleaning should only be performed by a tapestry cleaning expert. Depending on the wear and on the colour of the velvet, we recommend a professional deep cleaning every four to five years. In our experience, it is not always possible to remove the signs of wear on the seat by treating the fabric.

Do not use acids or alkali-based cleaners. Do not use stain removers, shoe cream, solvents, floor wax, cosmetics or other harsh cleaners. Do not use abrasive agents, steel wool, pot cleaners or similar. It is recommended to protect the product from abrasion, humidity and other factors so that the surface is not irreparably damaged.

For cleaning and care, it is recommended to brush the surfaces regularly using a soft brush (such as a clothes brush) following the natural grain of the fabric. Loose dust and dirt can be removed regularly from velvet by vacuuming with a special nozzle for tapestry or soft-bristled upholstery. The nozzle must not have protrusions or sharp edges, as they could damage the velvet. If necessary, you can clean the product with a damp suede, applying light pressure and following the natural grain of the fabric.

VELLUTO

I nostri tessuti in velluto devono essere lavati a secco. La pulizia profonda e la pulizia di macchie devono essere eseguite solo da un esperto addetto alla pulizia della tappezzeria. A seconda dell'usura e del colore del velluto, si consiglia una pulizia profonda professionale ogni quattro-cinque anni. Per la nostra esperienza, non è in ogni caso sempre possibile rimuovere i segni dell'usura sulla seduta trattando il tessuto.

Non utilizzare acidi o detergenti a base di alcali. Non usare smacchiatori, crema per scarpe, solventi, cera per pavimenti, cosmetici o altri detergenti aggressivi. Non utilizzare agenti abrasivi, lana d'acciaio, detergenti per pentole o simili. Si consiglia di proteggere il prodotto da abrasione, umidità e altri fattori in modo che la superficie non venga danneggiata irreparabilmente.

Per la pulizia e la cura, si consiglia di spazzolare regolarmente le superfici usando una spazzola morbida (come una spazzola per vestiti) seguendo le venature naturali del tessuto. La polvere e lo sporco sciolto possono essere rimossi regolarmente dal velluto aspirando con una speciale bocchetta per tappezzeria o imbottiti a setole morbide. La bocchetta non deve presentare risalti o spigoli vivi, poiché potrebbero danneggiare il velluto. Se necessario, è possibile pulire il prodotto con una pelle scamosciata umida, facendo una leggera pressione e seguendo le venature naturali del tessuto.

_maintenance

ROXANA VELVETS

100% Trevira CS

Width
App. 140 cm

Weight
450 g/m² (+/- 5%)

Abrasion resistance
180.000 Martindale cycles
(EN ISO 12947-2)

Pilling
4/5 (EN ISO 12945-2)

Flammability
UNI 9177 - Class 1
NF P 92-503-507 M1
California TB 117:2013
EN 1021-1&2
BS 5852-Part 0-1 (C&M)
DIN 4102 B1
IMO MSC 307(88)
Annex 1 Part 7-8
UNI 9175 1.IM

Cleaning
Dry-cleaning
Please see the ISO symbols

Light fastness
5 (EN ISO 105-B02)

Fastness to rubbing
Wet 4/5; Dry 4/5
(EN ISO 105X12)

Note
This product has been
piece-dyed, following a
certain mechanical working
process. Batch to batch
chromatic variations must
be considered as normal
and are to be evaluated
with the usual tolerance
of this type of fabric.
Work separately dye lots.



LARIO VELVETS

100% Cotton

Width
App. 140 cm

Weight
540 g/m² (+/- 5%)

Abrasion resistance
70.000 Martindale cycles
(EN ISO 12947-2)

Pilling
5 (EN ISO 12945-2)

Flammability
BS 5852-c&m
(With Coating)
California TB 117:2013

Light fastness
4/5 (EN ISO 105-B02)

Fastness to rubbing
Wet 4/5; Dry 4/5
(EN ISO 105X12)

Cleaning
Dry-cleaning
Please see the ISO symbols

Note
This product has been
piece-dyed, following a
certain mechanical working
process. Batch to batch
chromatic variations must
be considered as normal
and are to be evaluated
with the usual tolerance
of this type of fabric.
Work separately dye lots.



**BEDIF
FEREN
TBEUN
IQUE.**

LAURAMERONI s.r.l.
22040 Alzate Brianza (Como)
Via Manzoni, 2784
T +39 031 761450
info@laurameroni.com
www.laurameroni.com