

Plain cabinet system - Laurameroni collection

design Laurameroni



Cabinet system in smooth natural wood available in modules of different sizes, in all the wood finishes of the collection and in aniline-stained oak in all RAL colours. The system is available with horizontal and vertical grain.

Sistema di armadi in legno materico liscio, disponibile in moduli di diverse dimensioni, in tutte le finiture di legno della collezione e in rovere tinto anilina in tutti i colori RAL. Il sistema è disponibile con venatura orizzontale e verticale.



_dimensions

bases

basamenti – piétements – Unterstruktur – Нижний шкаф

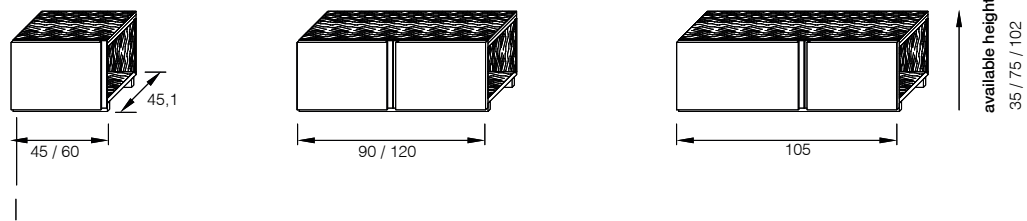

hanging unit

pensile – élément mural – hängeschränk- Навесной шкаф

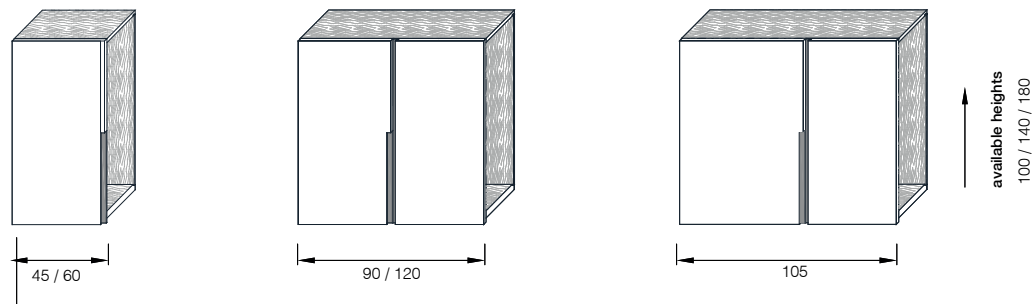

columns

colonne – colonnes – Säulen - колонны

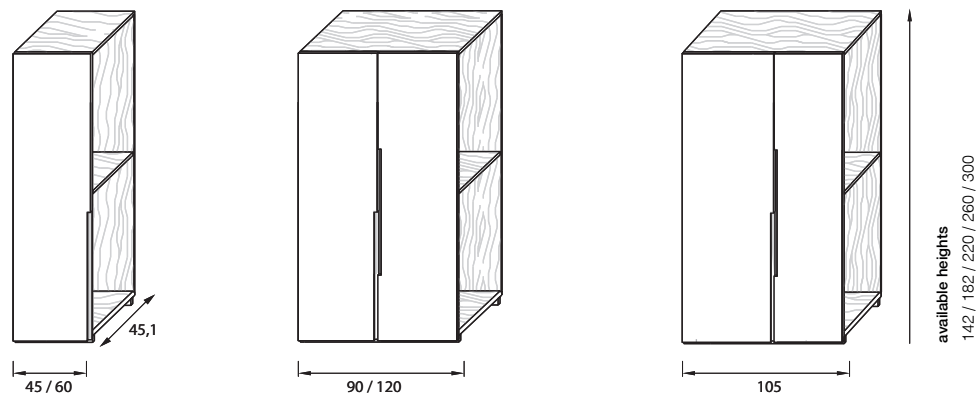

-Dimensions in centimeters and inches.

The right to discontinue and make changes is reserved.

This information is based on the latest product information available at the time of printing.

_dimensions

handles detail

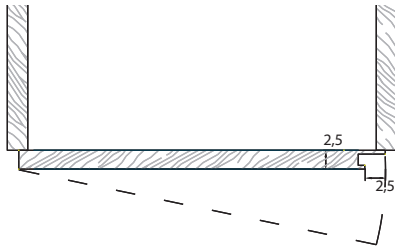

niche

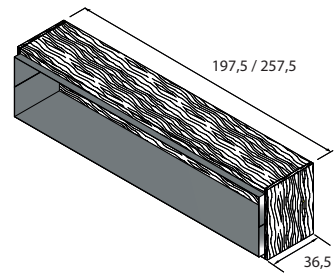

components

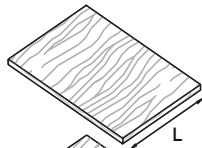

adjustable shelf
L. 42,5 / 57,5 / 87,5 / 102,5 / 117,5

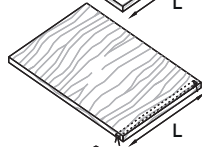

fixed shelf with led
L. 42,5 / 57,5 / 87,5 / 102,5 / 117,5

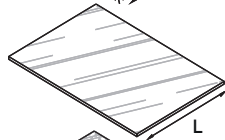

adjustable crystal shelf
L. 42,5 / 57,5 / 87,5 / 102,5 / 117,5

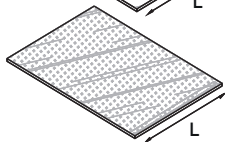

adjustable crystal fumé shelf
L. 42,5 / 57,5 / 87,5 / 102,5 / 117,5

columns handles

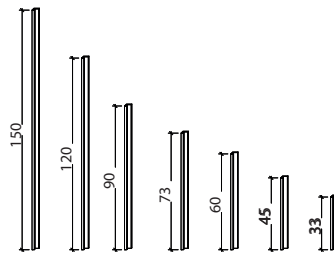

bases handles

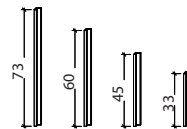

drawers

L. 34 / 49 / 79 / 94 / 109

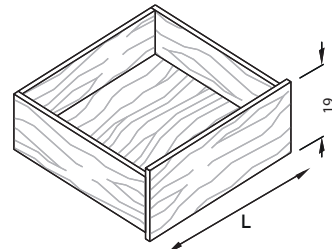
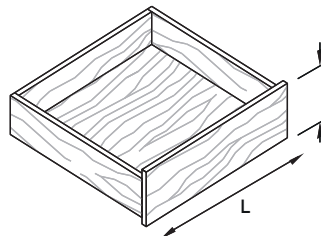
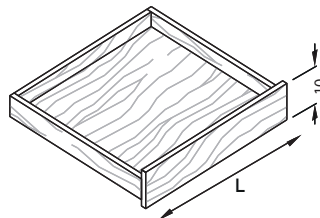

-Dimensions in centimeters and inches.
The right to discontinue and make changes is reserved.
This information is based on the latest product information available at the time of printing.

_dimensions

wood veneer

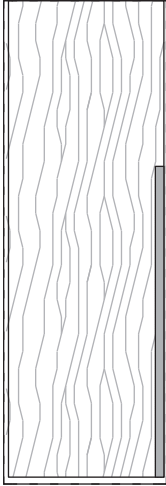

lacquered

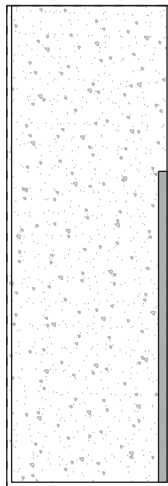

fabric

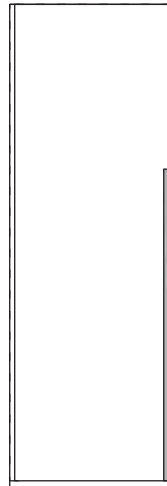

element for base unit

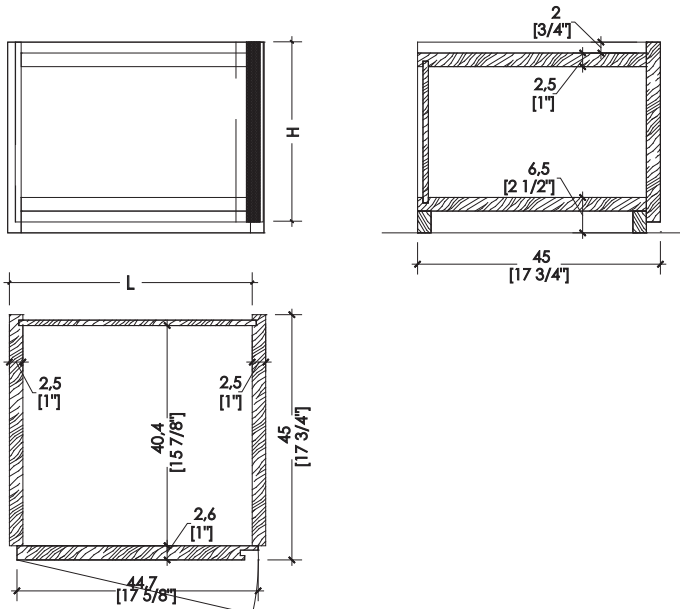

-Dimensions in centimeters and inches.
The right to discontinue and make changes is reserved.
This information is based on the latest product information available at the time of printing.

_dimensions

element for hanging unit

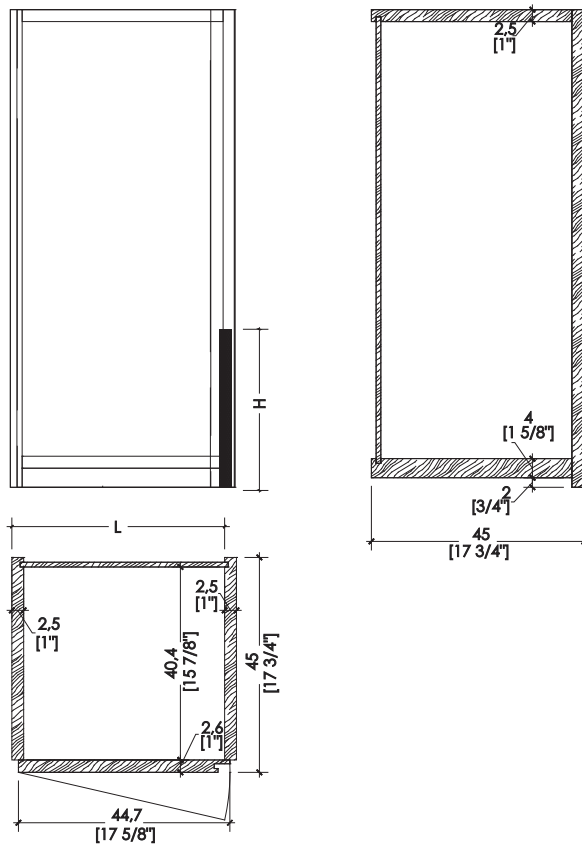

-Dimensions in centimeters and inches.
The right to discontinue and make changes is reserved.
This information is based on the latest product information available at the time of printing.

_dimensions

element for high storage unit

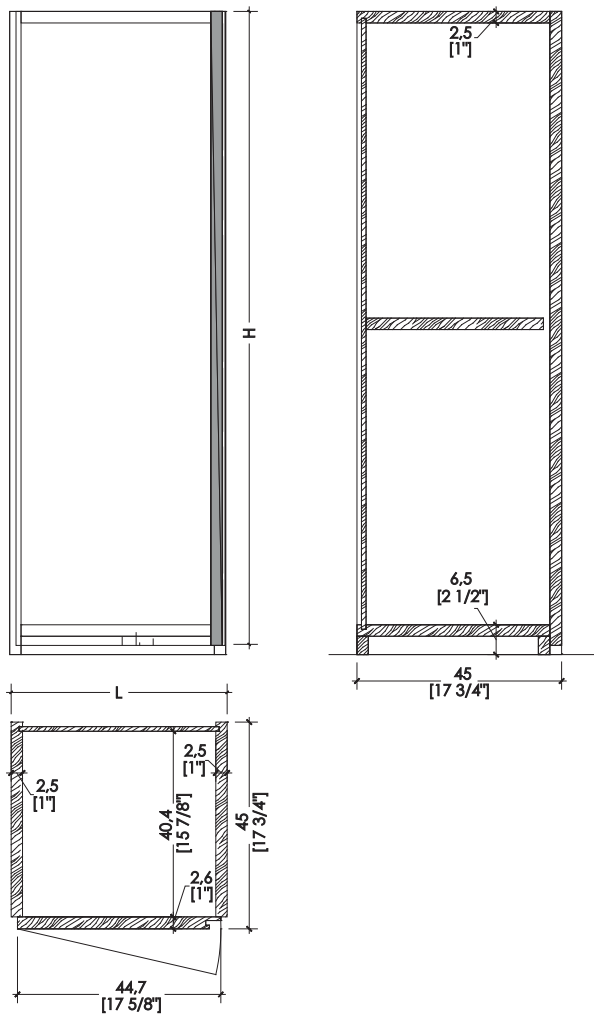

-Dimensions in centimeters and inches.
The right to discontinue and make changes is reserved.
This information is based on the latest product information available at the time of printing.

_dimensions

niche vertical section

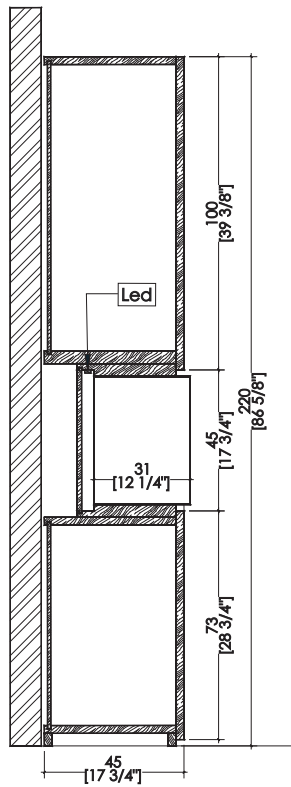

-Dimensions in centimeters and inches.
The right to discontinue and make changes is reserved.
This information is based on the latest product information available at the time of printing.

_materials & finishes

plain woods



Maple



Oak



Teak



Zebrano



Canaletto Walnut

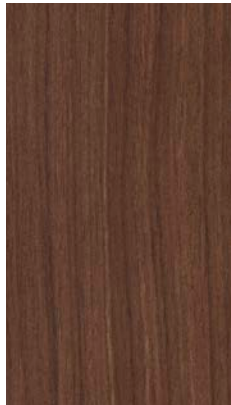

Dyed Canaletto walnut



Ebony



Termocotto Oak



Rosewood



Wenge



Aniline dyed



Available in all
RAL / NCS colors

_The finishes shown are indicative and refer to the entire production range.
Laurameroni reserves the right to modify the range without warning.

_materials & finishes for structure

brushed matt lacquered



Brushed matt lacquered



Available in all
RAL / NCS colors

_The finishes shown are indicative and refer to the entire production range.
Laurameroni reserves the right to modify the range without warning.

_maintenance

_ WOOD

Wood is a high-quality natural product. To maintain the natural character of wood and to protect surfaces from mechanical and chemical wear, veneered surfaces are coated with a high quality transparent paint. For cleaning and care, do not use acids or alkali-based cleaners, agents with bleaching additive, scouring powder, steel wool, pot scourers or similar. Anything hot or damp will cause damage to the surface. Remove soiling and liquids immediately. Use a dry soft cloth for cleaning, eventually add a little neutral cleaning agent to the water. The cloth must be only slightly damp, to prevent discolouration or swelling of the surface. It is then essential to rub the surfaces dry, so that there is no residual moisture.

Il legno è un prodotto naturale di alta qualità. Per mantenere il carattere naturale del legno e proteggere le superfici dall'usura meccanica e chimica, le superfici impiallacciate sono rivestite con una vernice trasparente di alta qualità. Per la pulizia e la cura, non usare detergenti acidi o alcalini, agenti con additivi sbiancanti, polveri abrasive, lana d'acciaio, spugne o simili. Qualsiasi cosa calda o umida causerà danni alla superficie. Rimuovere immediatamente sporco e liquidi. Utilizzare un panno morbido e asciutto per la pulizia, eventualmente aggiungere un po' di detergente neutro nell'acqua. Il panno deve essere solo leggermente umido, per evitare scolorimenti o rigonfiamenti della superficie. È quindi essenziale strofinare gentilmente le superfici asciutte, in modo che non ci sia umidità residua.

_maintenance

LACQUERED WOODS

Do not use acid or alkali-based cleaners. Do not use scouring agents, steel wool, pot cleaners or similar. Do not use solvents to clean painted surfaces. Pointed or sharp objects, such as blades or knives, can damage (scratch) the surface. Anything hot or damp will cause damage to the surface. Clean painted surfaces with a clean, soft, lint-free cloth to avoid abrasion with particles of dirt. For soft-finish paint surfaces, use a soft, lint-free, slightly damp cloth. If heavily soiled, paint surfaces can be cleaned more easily with a neutral (silicone-free) cleaning agent. Do not use furniture polish or other care products to clean soft-finish paint surfaces. It is then essential to rub the surface dry, so that there is no residual moisture. Clean painted surfaces regularly with a soft, lint-free cloth to remove dust.

Non utilizzare detergenti acidi o alcali. Non usare agenti abrasivi, lana d'acciaio, detergenti per pentole o simili. Non usare solventi per pulire le superfici verniciate. Oggetti appuntiti o taglienti, come lame o coltelli, possono danneggiare (graffiare) la superficie. Qualsiasi cosa calda o umida causerà danni alla superficie. Pulire le superfici verniciate con un panno pulito, morbido e privo di lanugine per evitare l'abrasione con particelle di sporco. Per superfici di vernice con finitura morbida, utilizzare un panno morbido, privo di lanugine e leggermente umido. Se molto sporchi, le superfici verniciate possono essere pulite più facilmente con un detergente neutro (privo di silicone). Non utilizzare lucidi per mobili o altri prodotti per la cura per pulire le superfici di vernice. È quindi essenziale strofinare delicatamente la superficie asciutta, in modo che non vi sia umidità residua. Pulire regolarmente le superfici verniciate con un panno morbido e privo di lanugine per rimuovere la polvere.

**BEDIF
FEREN
TBEUN
IQUE.**

LAURAMERONI s.r.l.
22040 Alzate Brianza (Como)
Via Manzoni, 2784
T +39 031 761450
info@laurameroni.com
www.laurameroni.com